



ACE
2015 WILD BIRD
SIGNAGE KIT

WILD BIRD

Signage Kit — Installation Guide



INTRODUCTION

Bird watching, feeding and housing is the fastest-growing outdoor activity in the United States. Based on a survey by the U.S. Fish and Wildlife Service; 51.3 million Americans reports that they watch birds. More and more people are taking up this hobby as a regular activity. Our goal is to provide customers the atmosphere and information needed to make their purchasing decisions, making Ace their Wild Bird hobby headquarters.

**For questions regarding signage
and hardware, Please contact:**



Phil Schau, 847-873-0034 x103
or phil@retailfirstcorp.com

**For questions regarding orders
or replacements, Please contact:**



Kerry Marrotta, 630-990-8422
or decororders@acehardware.com

WILD BIRD

Signage Kit — Installation Guide

ELEMENTS



Wild Bird Signage Program (16' Set shown)
Kits include: Overhang feeder grids with upright brackets, grid bird graphics, backer paper, overhang graphic and POP informational shelf spinner.

WILD BIRD

Signage Kit — Installation Guide

CONTENTS INCLUDED BY KIT



	ITEM	DESCRIPTION	KIT (QTY)
CONVENIENCE 8' Kit 8'	Overhang Feeder Grids	48" W x 24" D	2
	Overhang Grid Brackets	24" Bracket and Adapter	3
	Overhang Bird Graphics	48" W x 24" H	2
	Overhang Grid Puck	24" W x 10" H	1
	Backer Paper	46" W x 84" H	2
	Shelf Spinner	46" W x 3" H, (24) POP Cards	1



	ITEM	DESCRIPTION	KIT (QTY)
CORE 12' Kit 12'	Overhang Feeder Grids	48" W x 24" D	3
	Overhang Grid Brackets	24" Bracket and Adapter	4
	Overhang Bird Graphics	48" W x 24" H	3
	Overhang Grid Puck	24" W x 10" H	1
	Backer Paper	46" W x 84" H	3
	Shelf Spinner	46" W x 3" H, (24) POP Cards	1



	ITEM	DESCRIPTION	KIT (QTY)
SUPER 16' Kit 16'	Overhang Feeder Grids	48" W x 24" D	4
	Overhang Grid Brackets	24" Bracket and Adapter	5
	Overhang Bird Graphics	48" W x 24" H	4
	Overhang Grid Puck	24" W x 10" H	1
	Backer Paper	46" W x 84" H	4
	Shelf Spinner	46" W x 3" H, (24) POP Cards	1



	ITEM	DESCRIPTION	KIT (QTY)
EXPANDED 24' Kit 24'	Overhang Feeder Grids	48" W x 24" D	6
	Overhang Grid Brackets	24" Bracket and Adapter	8
	Overhang Bird Graphics	48" W x 24" H	6
	Overhang Grid Puck	24" W x 10" H	2
	Backer Paper	46" W x 84" H	6
	Shelf Spinner	46" W x 3" H, (24) POP Cards	2



24' RUN



24' VALLEY



WILD BIRD

Signage Kit — Installation Guide

BIRD REPRESENTATION BY REGIONS - 48" X 24" OVERHANG GRAPHICS



PANEL 1



SIDE 1 - RUBY THROATED HUMMINGBIRD - MALE



SIDE 2 - RUBY THROATED HUMMINGBIRD - FEMALE

PANEL 2



SIDE 1 - EASTERN BLUEBIRD



SIDE 2 - INDIGO BUNTING

PANEL 3



SIDE 1 - CARDINAL



SIDE 2 - ROSE BREASTED GROSBREAK

PANEL 4



SIDE 1 - AMERICAN GOLDFINCH



SIDE 2 - PURPLE FINCH

PANEL 5



SIDE 1 - DOWNY WOODPECKER



SIDE 2 - BLACK CAP CHICKADEE

CONVENIENCE KIT – 8'

- Panel 2-** Eastern Bluebird (for the North and East regions)
Indigo Bunting (for the South and West regions)
- Panel 3-** Cardinal (primarily found in the Midwest, Northwest and South-not found in the Rockies)
Rose Breasted Grosbeak (for the South and West Regions)

CORE KIT – 12'

- Panel 1-** Male Ruby Throated hummingbird
American Robbin
- Panel 2-** Eastern Bluebird (for the North and East regions)
Indigo Bunting (for the South and West regions)
- Panel 3-** Cardinal (primarily found in the Midwest, Northwest and South-not found in the Rockies)
Rose Breasted Grosbeak (for the South and West Regions)

CORE KIT – 16'

- Panel 1-** Male Ruby Throated hummingbird
American Robbin
- Panel 2-** Eastern Bluebird (for the North and East regions)
Indigo Bunting (for the South and West regions)
- Panel 3-** Cardinal (primarily found in the Midwest, Northwest and South-not found in the Rockies)
Rose Breasted Grosbeak (for the South and West Regions)
- Panel 4-** American Goldfinch (throughout the US)
Purple Finch (East of the Mississippi and west coast – not found in the Rockies)

CORE KIT – 24'

- Panel 1-** Male Ruby Throated hummingbird
American Robbin
- Panel 2-** Eastern Bluebird (for the North and East regions)
Indigo Bunting (for the South and West regions)
- Panel 3-** Cardinal (primarily found in the Midwest, Northwest and South-not found in the Rockies)
Rose Breasted Grosbeak (for the South and West Regions) **QTY: 2**
- Panel 4-** American Goldfinch (throughout the US)
Purple Finch (East of the Mississippi and west coast – not found in the Rockies)
- Panel 5-** Downy Woodpecker (throughout the US)
Black Cap Chickadee (found in Northern US)

PLEASE NOTE: Bird species may vary based on specific regions. Bird representation are general recommendations. Store owners are free to adjust images as they seem fit for their specific region.

1

Hold backer paper aligned with top of backer board centered left to right.

2

Use tree clips provided to secure top left and right corners. Be sure to pull paper tight for smooth application.

3

Insert tree clips as you go down left to right on the board. Use (4) clips on the left and (4) clips on the right working your way down.

NOTE: See numerical order on the right for correct application.

4

Insert excess paper behind the baseboard for clean finish.

NOTE: Be sure to pull paper tight as you move downward for smooth application.

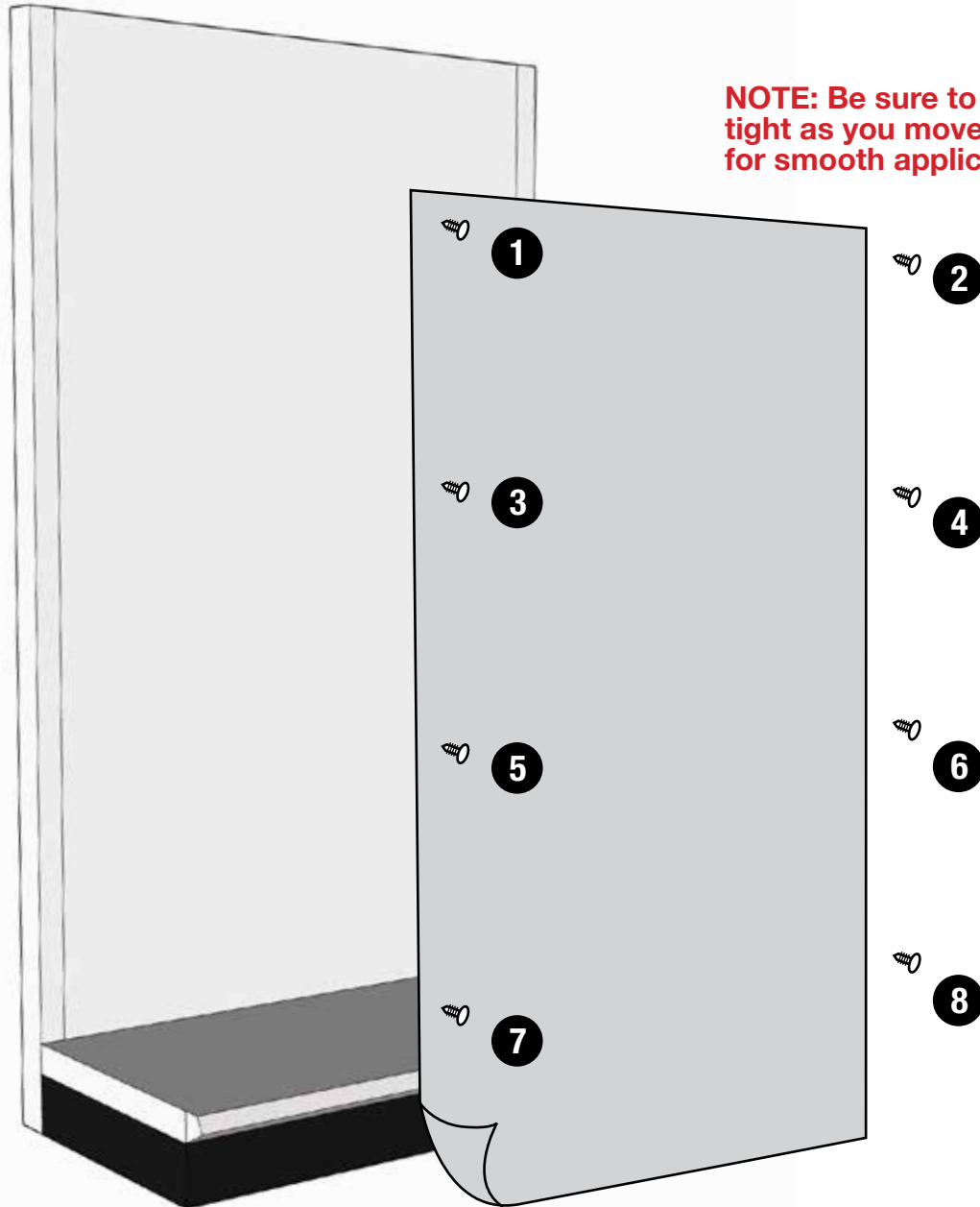

DO YOU NEED IN-LINE OR WALL MOUNT BRACKETS? (BOTH TYPES INCLUDED IN KITS)

IN-LINE APPLICATION

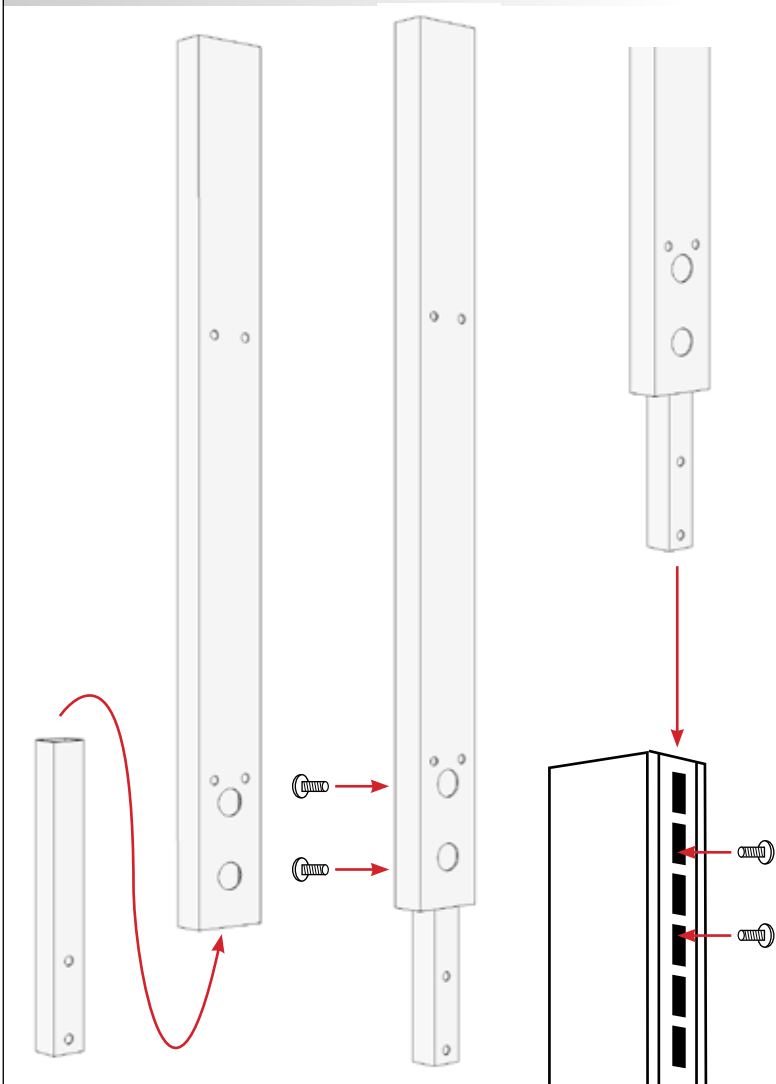

TOP MOUNT APPLICATION

Screw upright adapter into bracket as shown using 1/4-20 bolts provided. Once secure slide bracket into top of upright and bolt into place using 1/4-20 bolts provided.

STREATOR ADAPTER

(For use with streator fixtures only)



For adapter orders please contact:
decororders@acehardware.com

IMPORTANT: Please note how many adapters will be needed prior to order.

STREATOR APPLICATION

Insert bracket into face of streator upright. Tighten into place with tension screw included.

WALL MOUNT APPLICATION

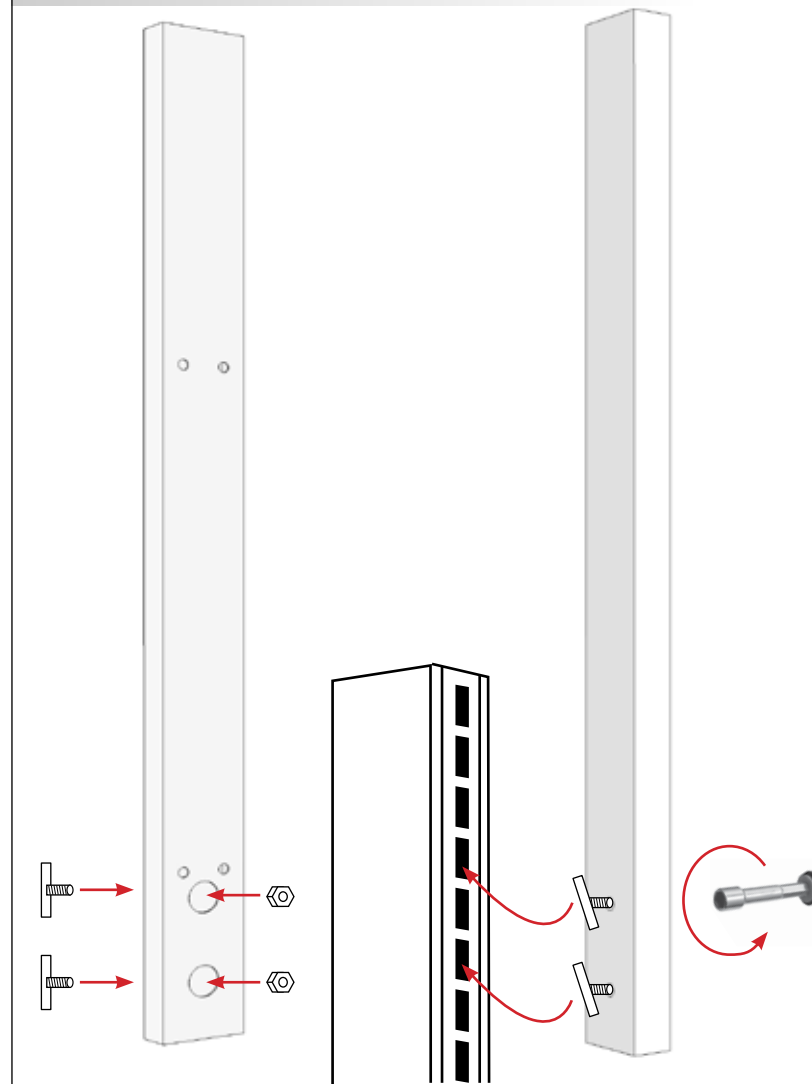

FRONT MOUNT APPLICATION

Screw screw "T" nuts into bracket as shown. "T" nuts secure into front of upright. Use nut driver to tighten "T" nuts into upright securing in place.

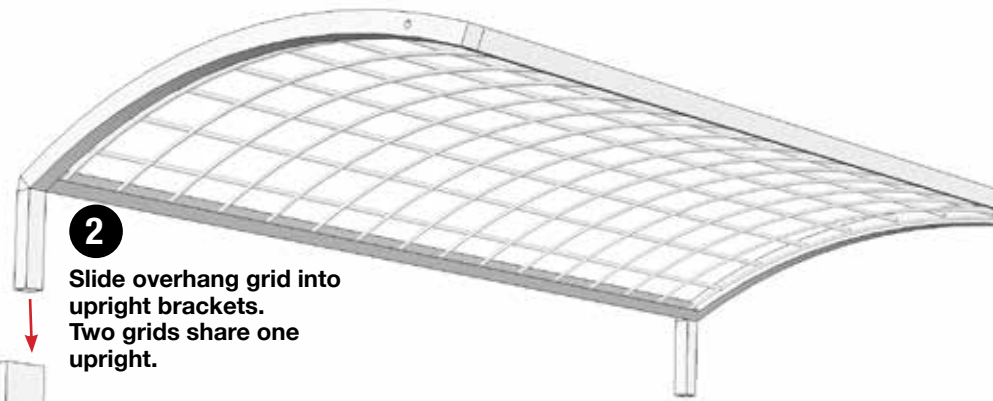

2
Slide overhang grid into upright brackets. Two grids share one upright.

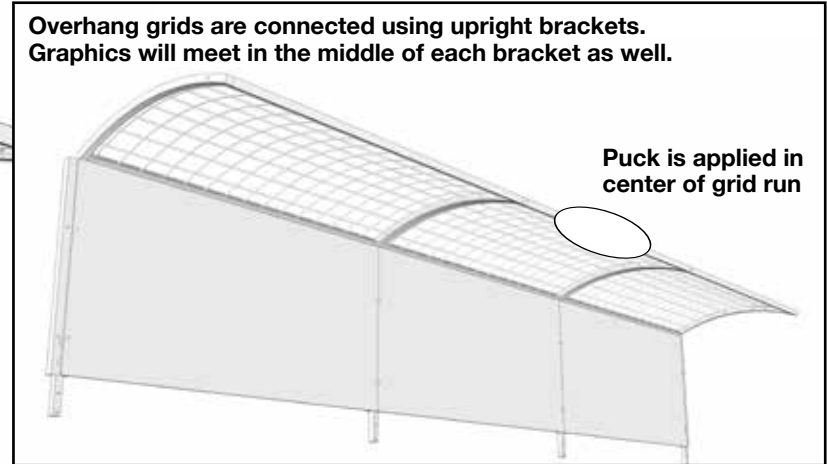

Overhang grids are connected using upright brackets. Graphics will meet in the middle of each bracket as well.

Puck is applied in center of grid run

1
Secure grid brackets to face of upright. (FRONT mount only)

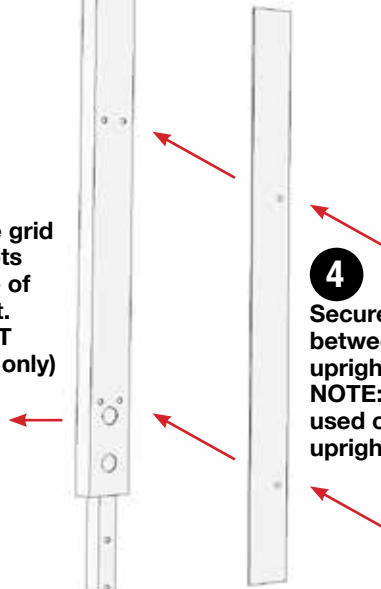

4
Secure end coverings between graphics and upright. NOTE: This will only be used on the outside most upright brackets.

1
Secure grid brackets into top of upright. (TOP mount only)



3
Secure graphics to the front of the brackets using tree clips provided.

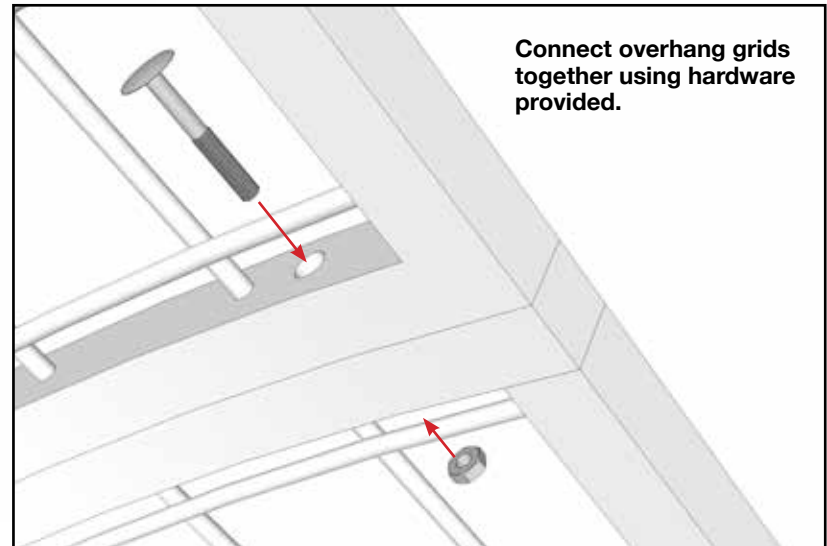
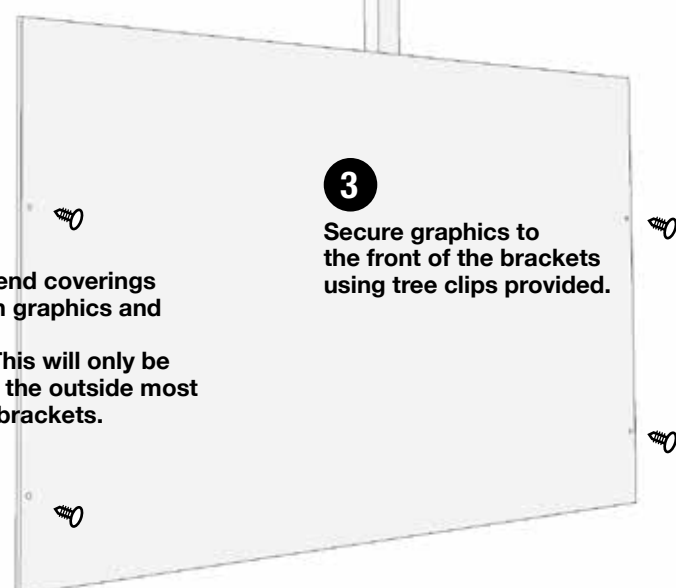

Connect overhang grids together using hardware provided.

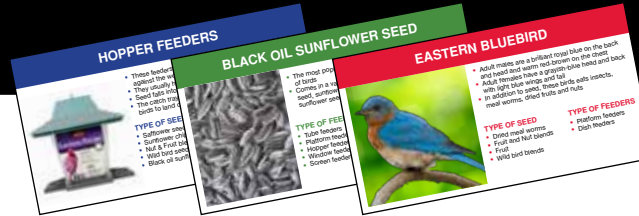

POP cards for Bird, Seed and feeders included with set.

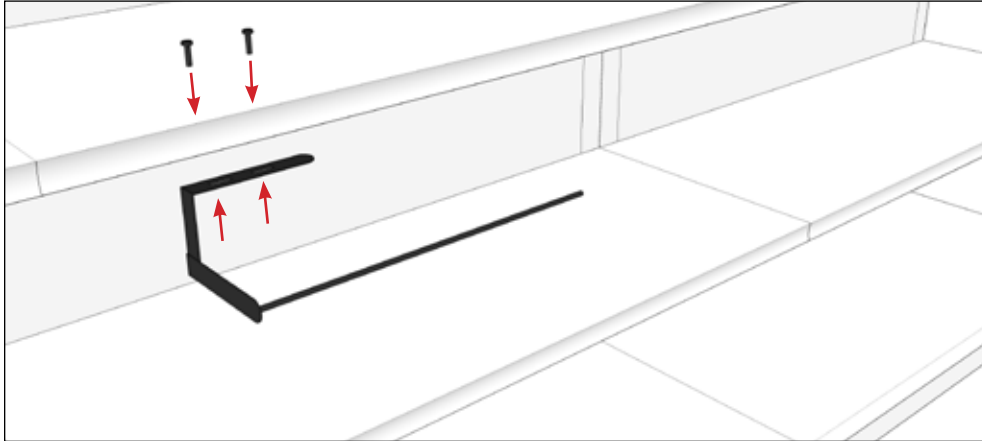

STEP 1
Secure left spinner bracket as shown from under shelf. Location can be adjusted as needed.

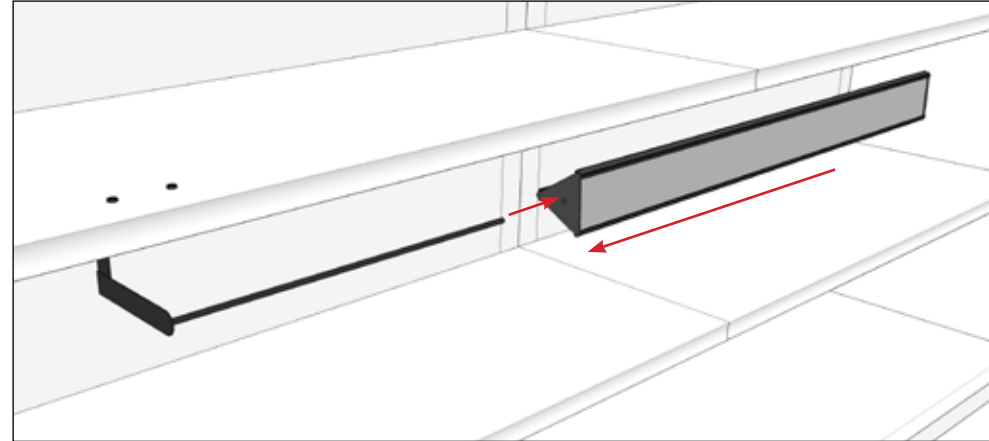

STEP 2
Once bracket is secured to shelf, slide spinner over bracket rod. Slide until spinner hits bracket side.

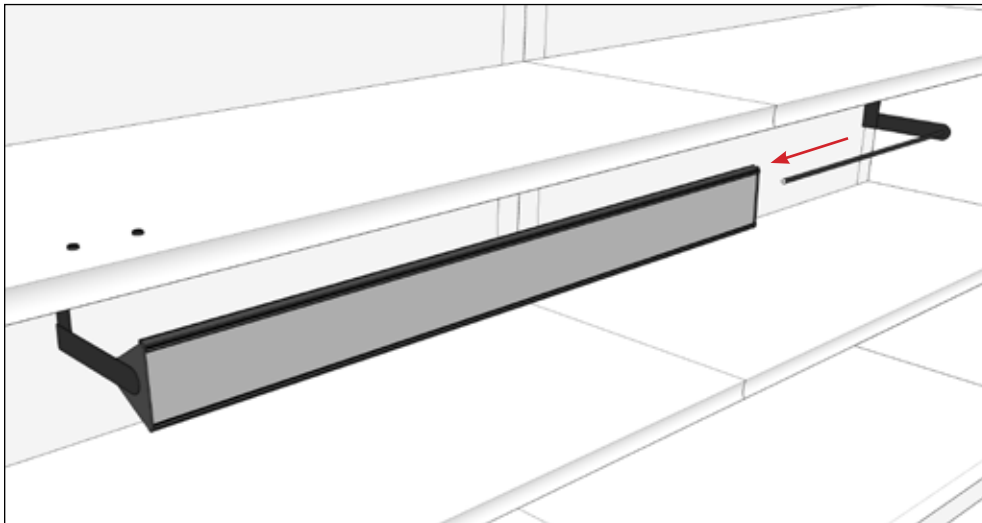

STEP 3
Insert right bracket rod into spinner completely on opposite side.

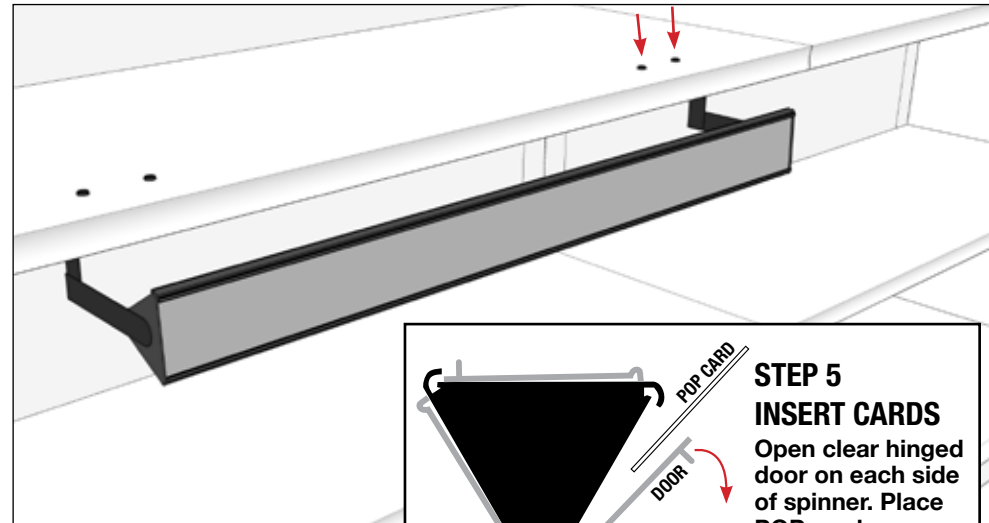

STEP 4
Secure right spinner bracket as shown from under shelf. Spinner will now be secure and spin freely.

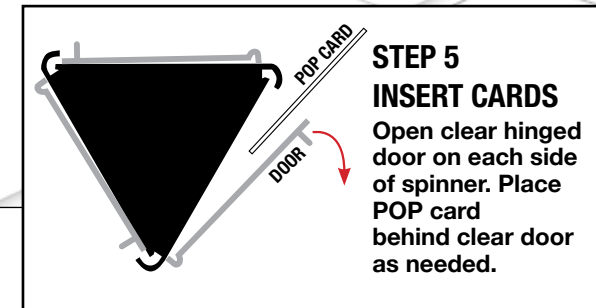

STEP 5
INSERT CARDS
Open clear hinged door on each side of spinner. Place POP card behind clear door as needed.



Wild Bird Overhead
72" W x 30" H.
Sign hardware included.

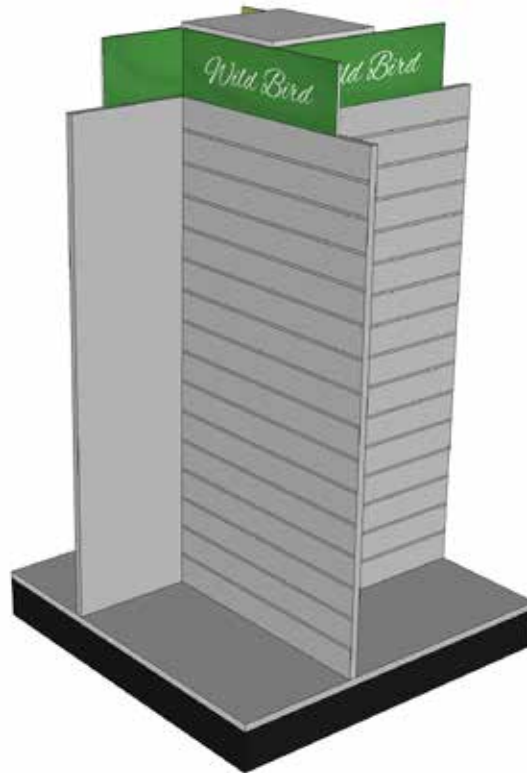

4-Way Display
48" W x 48" D x 48" H
Includes (10) shelves,
casters and graphics.



Wide Span Merchandiser
48" W x 48" D x 7' H. Includes wide span unit, wood facade, kick plates, top cage and overhang puck graphics.

Note: Determine placement prior to assembly. Once facade is in place, unit can be difficult to move.

OPTIONAL ELEMENTS ARE SOLD SEPARATELY
(Assembly instructions will be included)